

DIMENSIONS OF STUD LINK CHAIN

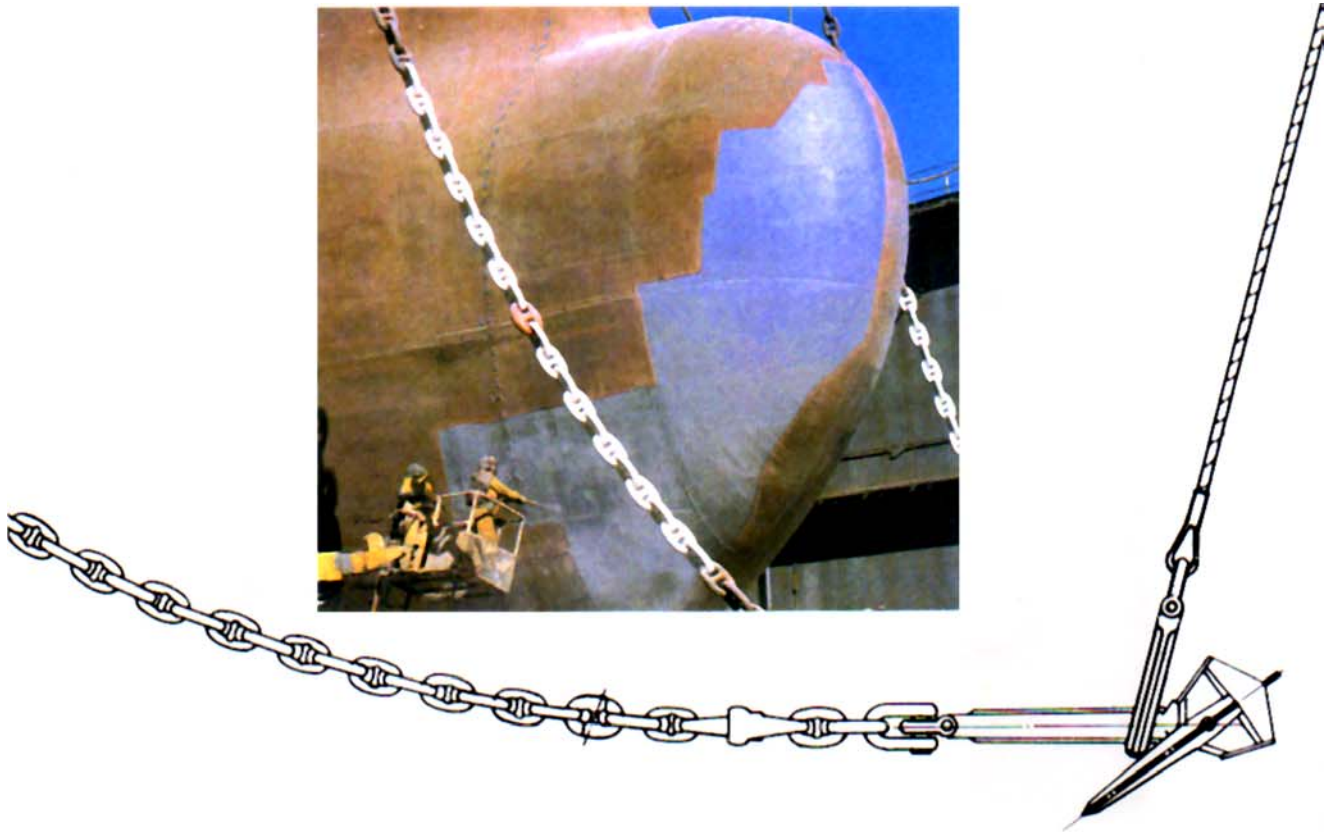

a. Common Link

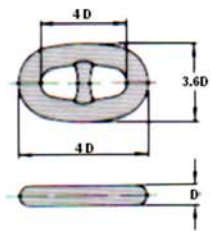

b. Englarged Link

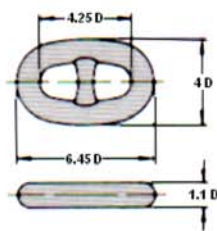

c. End Link

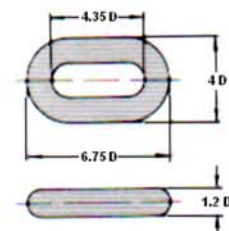

e. Kenter Shackle

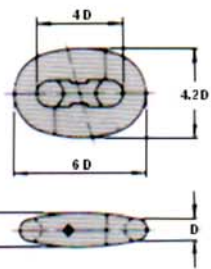

f. D Type Joining Shackle

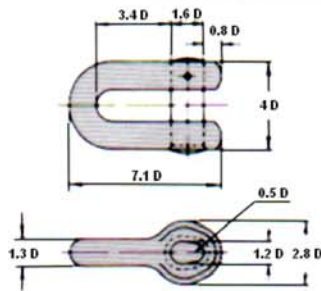

g. D Type Anchor Shackle

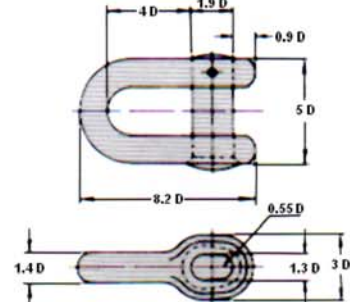

h. Pear End Shackle

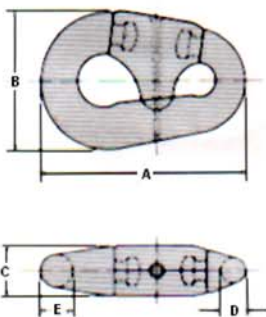

j. Swivel (Grade 2)

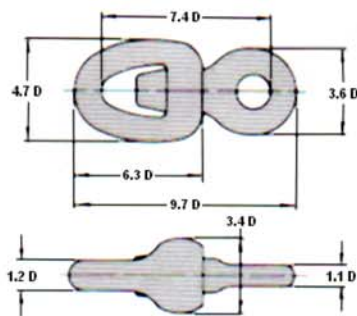

k. Swivel Shackle (All Grades)

